

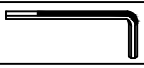



















ASSEMBLY INSTRUCTION

PC 201

HELP LINE NUMBER 01443 816982

PAGE 1

A		M4	1PC
B		1/4"*80mmL	12PCS
C		1/4"*15mmL	4PCS
D		1/4"*25mmL	8PCS
E		M4*12mmL	4PCS
F		Ø20*5mm	4PCS
G		Brown end caps	8PCS
H		M4"*10mmL	4PCS
I		Left leg	1PC
J		Right leg	1PC
K		Top metal frame	1PC
L		Middle metal frame	1PC
M		Left metal tube	1PC
N		Right metal tube	1PC
O		Wood cross bar	1PC
P		Keyboard	1PC
Q		Top glass	1PC
R		Middle glass	1PC
S		Left metal slide	1PC
T		Right metal slide	1PC
U		Rubber Pad	6PC

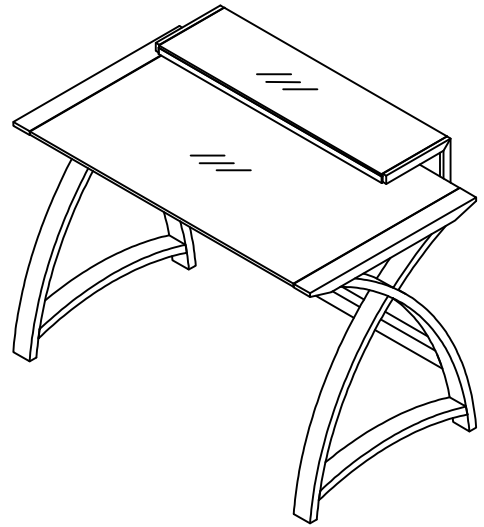

STEP 1

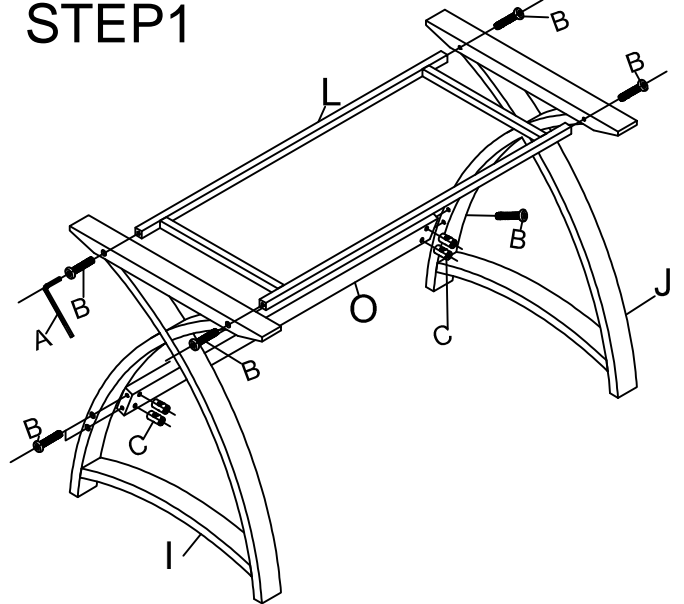

STEP 2

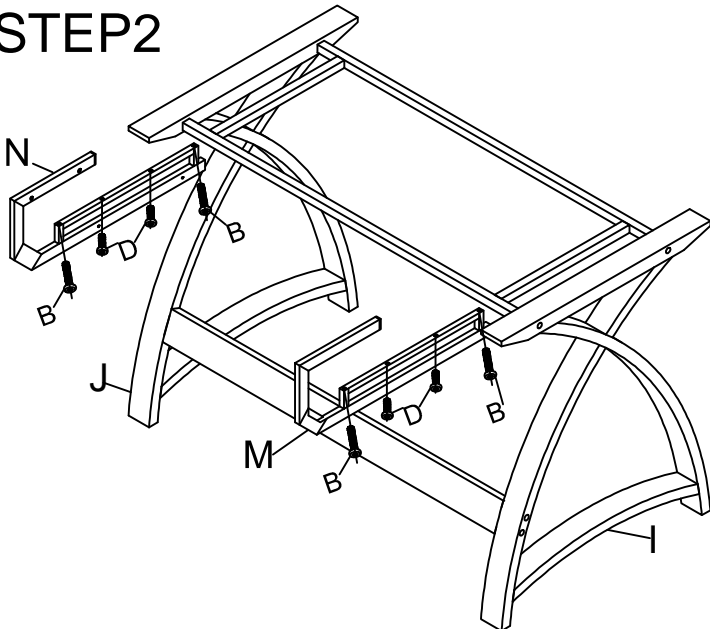

STEP 3

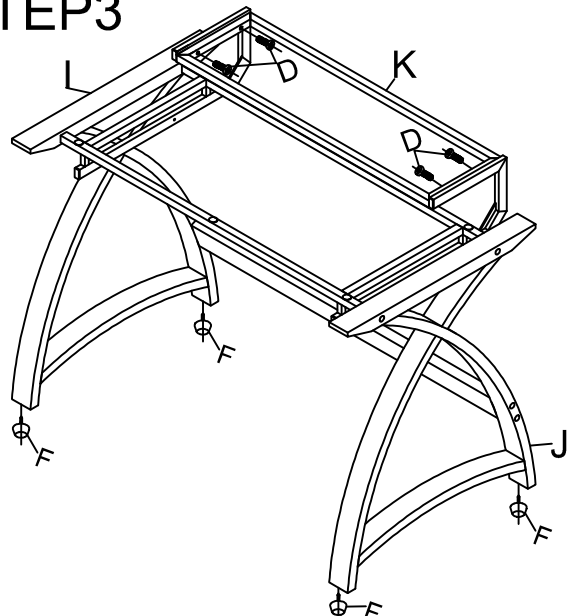





















ASSEMBLY INSTRUCTION

PC 201

HELP LINE NUMBER 01443 816982

PAGE 2

A		M4	1PC
B		1/4" * 80mmL	12PCS
C		1/4" * 15mmL	4PCS
D		1/4" * 25mmL	8PCS
E		M4 * 12mmL	4PCS
F		Ø20 * 5mm	4PCS
G		Brown end caps	8PCS
H		M4 * 10mmL	4PCS
I		Left leg	1PC
J		Right leg	1PC
K		Top metal frame	1PC
L		Middle metal frame	1PC
M		Left metal tube	1PC
N		Right metal tube	1PC
O		Wood cross bar	1PC
P		Keyboard	1PC
Q		Top glass	1PC
R		Middle glass	1PC
S		Left metal slide	1PC
T		Right metal slide	1PC
U		Rubber Pad	6PC

STEP 4

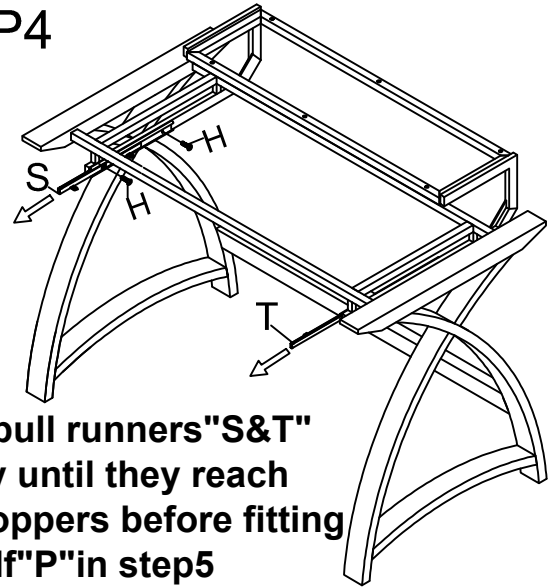

Please pull runners "S & T" out fully until they reach their stoppers before fitting the shelf "P" in step 5

STEP 5

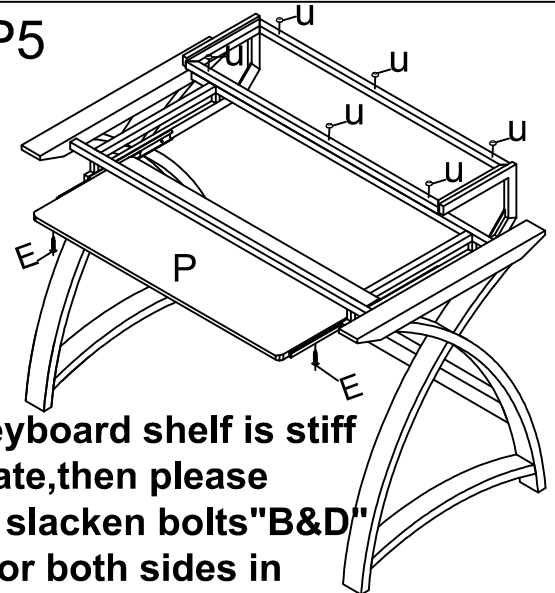

If the keyboard shelf is stiff to operate, then please slightly slacken bolts "B & D" on one or both sides in step 2 until it moves freely.

STEP 6

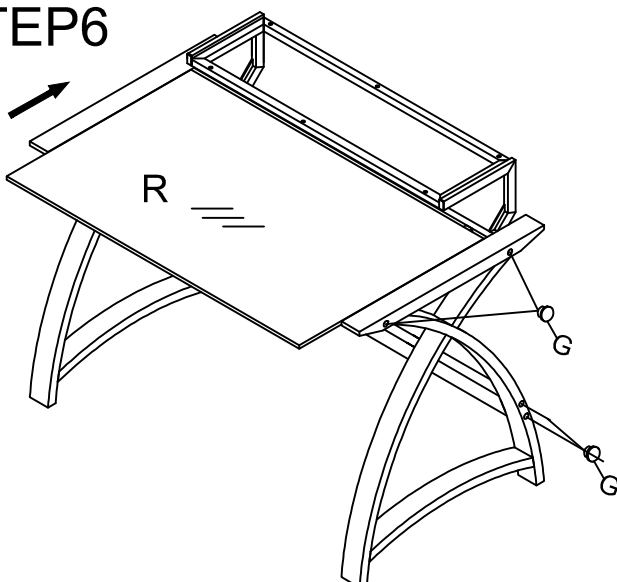

STEP 7

